

## Who We Are ?

CONNECTING YOUR BUSINESS TO THE OIL SEAL & RUBBER YOU NEED

Pruma Seals Pvt. Ltd. designs and manufactures the most durable seals available and delivers them with in same days through our turning technology.

Our Mission: Durable seals and just in time manufacturing process The mission of Pruma Seals Pvt. Ltd. is to offer our customer or end user the most durable seals available, delivered with in a day thorough just in time manufacturing process

We design and manufacture both non-standard and standard seals using ISO 9000 compliance processes at our state-of-the-art of fidelity. Because our seals last longer, they are the most cost-effective you can buy. and you get them when you need them.

## Advantage Of Pruma Seals Pvt. Ltd.

### Durable seals are manufacture from most advanced materials:

Durable begins with materials. Pruma Seals Pvt. Ltd. has an ongoing commitment to utilize advanced materials designed to give our customers maximum life of seals. We partner with leading edge raw-material developers to make new and advanced material available to our customer in the seals we make for them.

Our Experienced Staff offers Seal Durability The engineers of Pruma Seals Pvt. Ltd. have's experience in designing and manufacturing seals, gained in different part of the world the past 20 years. With filed and theoretical experience, our engineers are uniquely qualified to understand end user requirement, ensuring them to get the right seal in the right material. And deliver those seals either standard or non-standard within days.

### After - Sales Services Ensures Maximum Life of Seals

Our long-term commitment ensure to your company starts once we ship your seals. Our engineer work with your engineers together to aid in the continuous improvement in the performance of your seals and your equipment. Additional information gained during the after- sales process can lead to further advances in both equipment and seal durability.

## OIL SEAL & RUBBER A TOTAL END TO END

### Gaskets

Available with us is in wide range of Rubber Gasket that is procured from market leading vendors in India. We insure that we avail high quality and high performance rubber gasket from them. These Rubber Gasket have been specifically designed to sustain high temperature and pressure in chemical, steam & oil industry.

### Diaphragms

We manufacture Rubber Diaphragms for application like Pumps, Actuators, LPG valves, CNG Valves, Wax Actuators, Thermal Actuators, Gas Diaphragms and Pressure Diaphragms.

### 'O' Rings

'O' Rings are basically used to prevent leakage of fluid or gases, the "O" Rings working as a seal when installed in gland or their cavity of a rigid component & we manufacture 'O' Rings from 1mm ID to any size of diameter in one piece.

HYDRAULICS OIL SEALS & RUBBER MATERIAL DATA

## Material Data

Properties	Polyurethane					Rubber Elastomers					Thermoplastics			
	DIN Standard	Unit	PU	H-PU	G-PU	NBR	H-NBR	Viton	EPDM	Silicon	POM	PTFE Virgin	PTFE w.filler	PA
Hardness	53505	Shore A	94±2	95±2	93±2	85±5	85±5	85±5	85±5	85±5				
Hardness	53456	Shore D	50±2	48±3	48±2								68	
Bulk Density	53479	g/cm <sup>3</sup>	1.17	1.21	1.21	1.28	1.23	2.30	1.24	1.45	1.41	2.16	2.4+0.1	1.41
100% Tensile Stress	53504	N/mm <sup>2</sup>	12	15	12	9	11	10		4.2				
Tensile Strength	53504	N/mm <sup>2</sup>	55	50	48	16	20	15	10	8		27 along 26 across	15	
Elongation At Tear	53504	%	440	350	350	140	200	195	150	120	40	390 along 450 across		90
Compression Set -40°c/22h														
70°c/70h														
100°c/22h	53517	%	20	19	20	19	20	7.7	31	22				
175°c/22h														
Permanent Set	53512	%	44	34	43		28		34	40				
Tear Strength	53515	N/mm	115	110	75	8	7	5	9	13				
abrasion	53516	mm <sup>3</sup>	15	17	25	130	110	240	150					
Lower Temperature oc Limit		°c	-35	-20	-20	-30	-25	-20	-50	-50	-50	-200	-200	-40
Upper Temperature oc Limit		°c	110	115	110	100	150	200	150	200	100	260	260	100

## Rubber Data

Polymer	Astrm. Designation (D1 418)	Dura (D1 418)	Abrasion Resistance	Temp Range	Compression Set	Advantage
Styrene Butadience	SBR	35-90°A	Excellent	-65°F to 225°F	Good	Heat Resistance & Ozone Resistance
Silicon	SI	30-85°A	Poor	-120°F to 425°F	Good	Heat Resistance & Ozone Resistance
Natural Polyisoprene	NR	35-95°A	Excellent	-65°F to 180°F	Good	Heat Resistance & Ozone Resistance

## Piston Seals

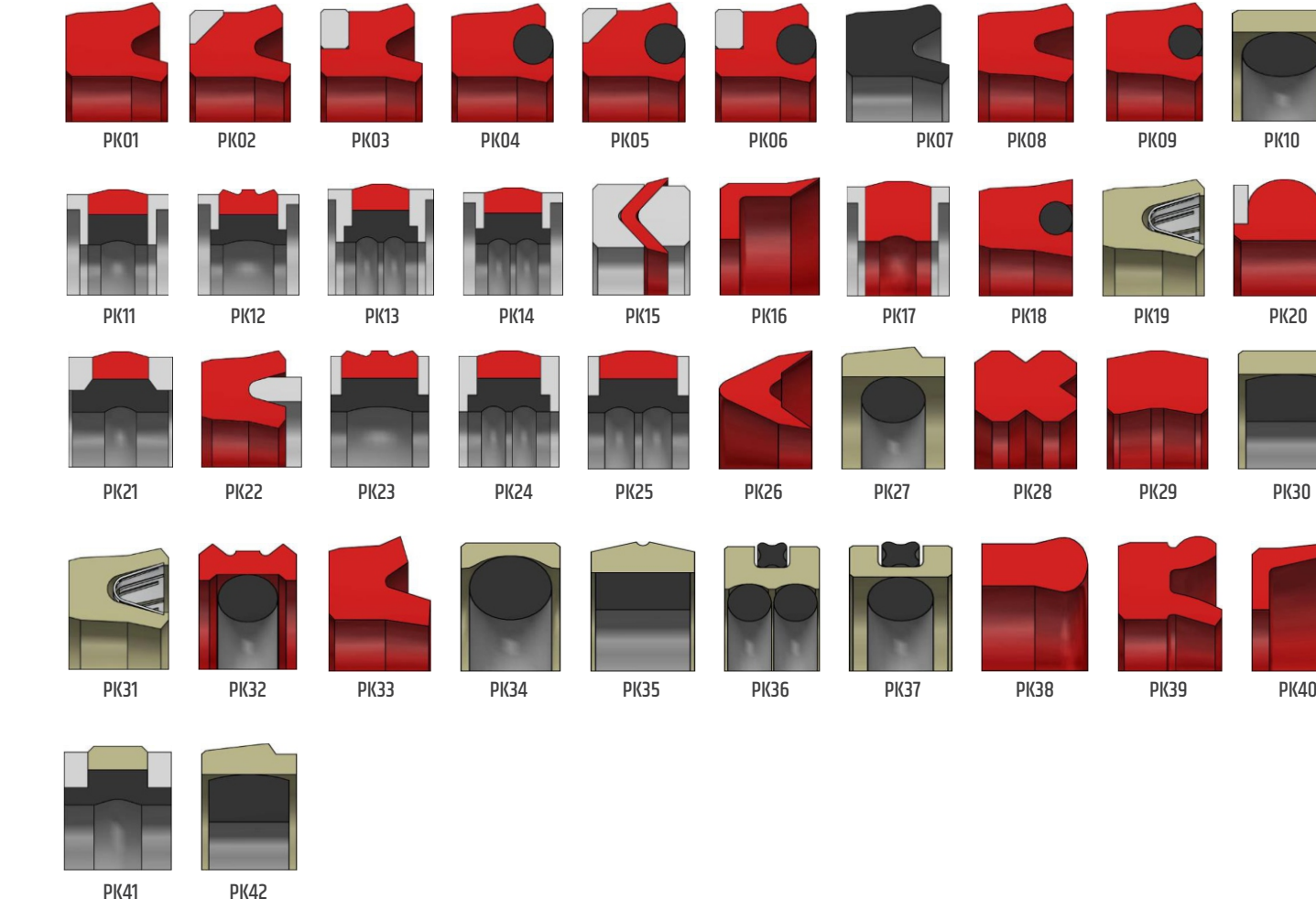

## GUIDE RINGS & WEAR BANDS

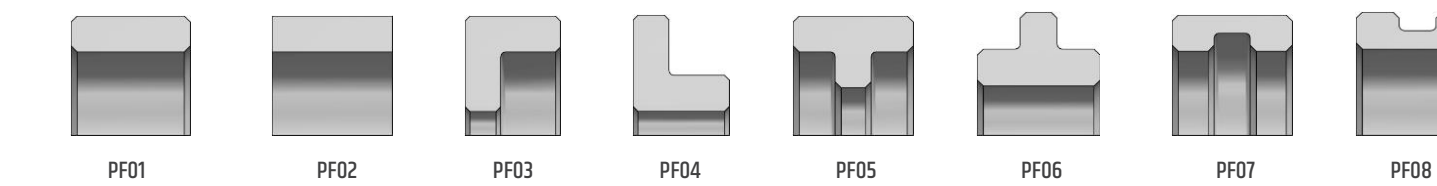

## GASKETS

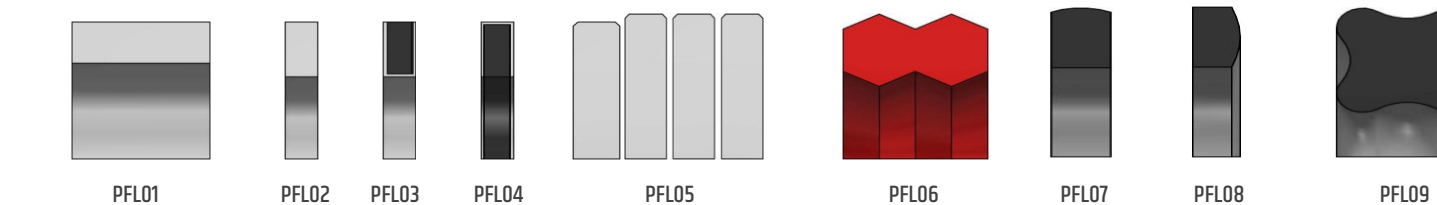

HYDRAULICS OIL SEALS

## ROD SEALS

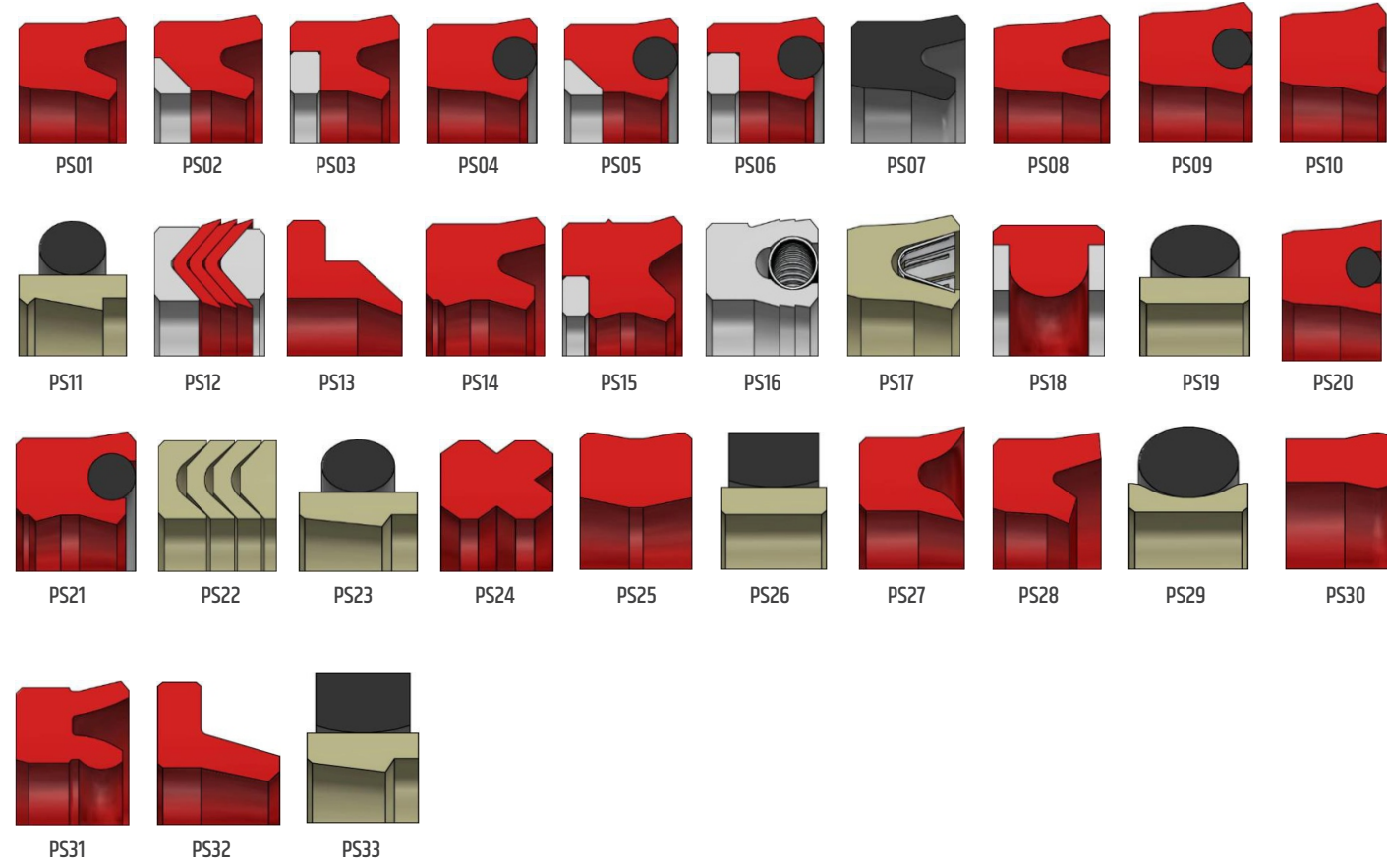

## WIPER SEALS

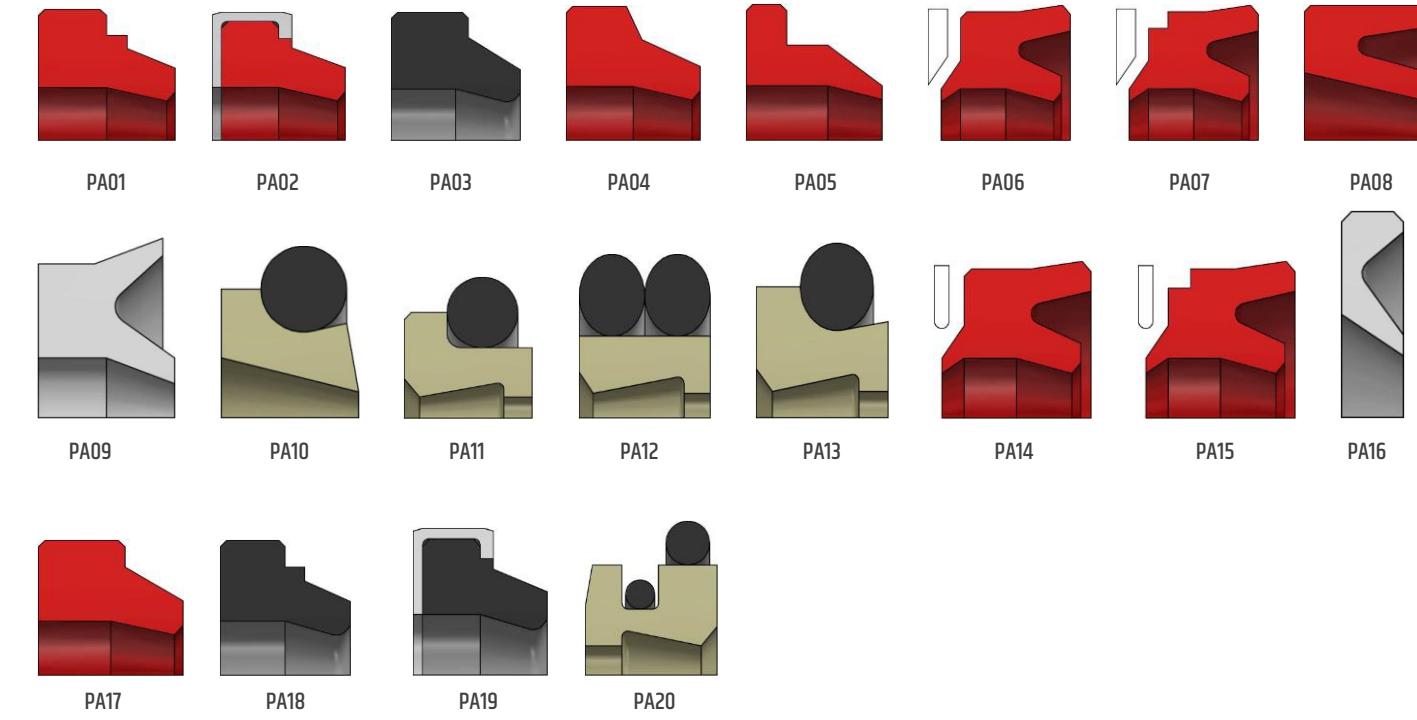

## ROTARY SEALS

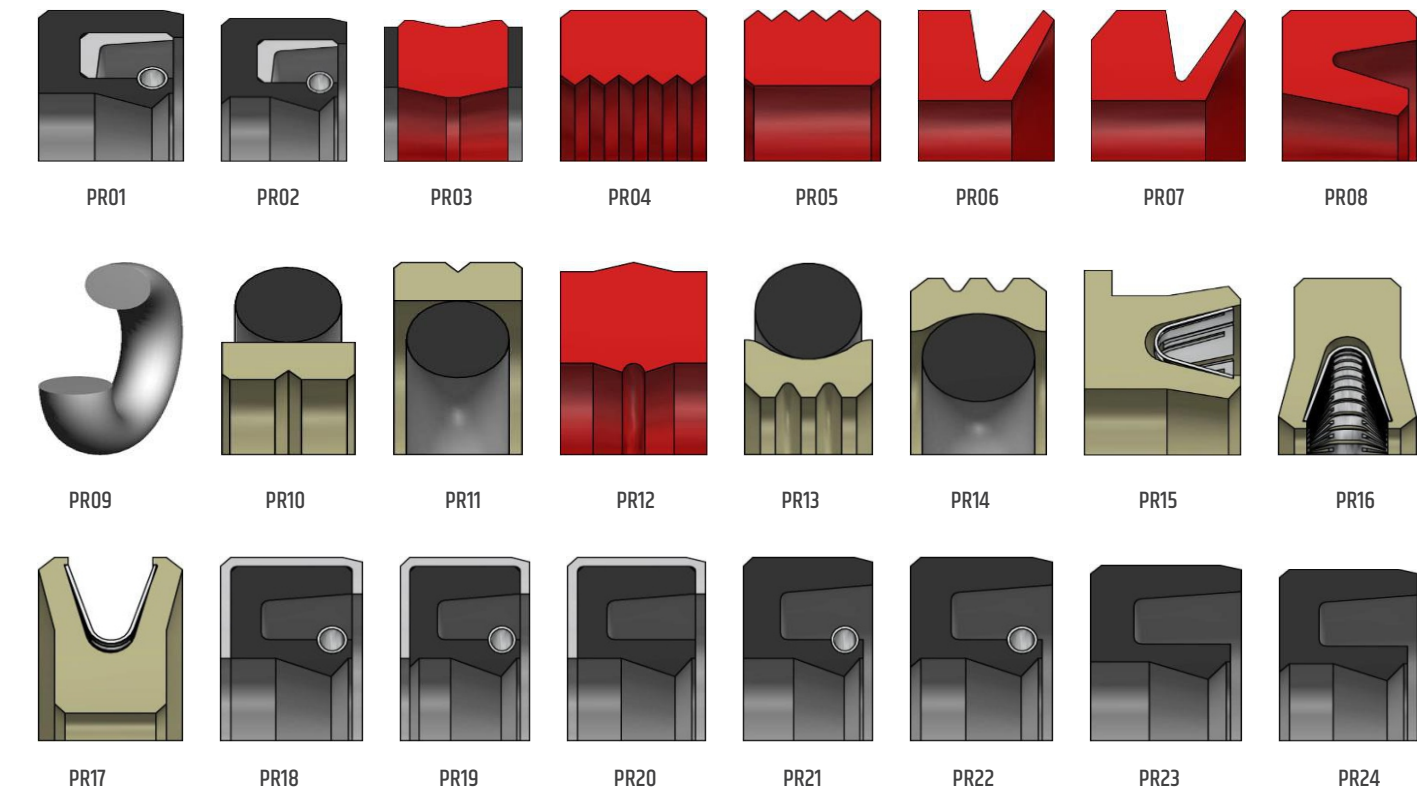

## BACKUP RINGS

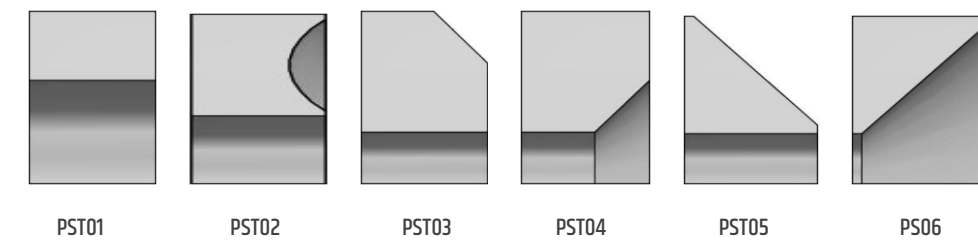

## O-RING

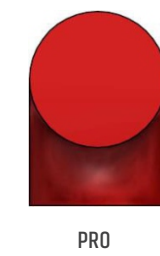

Anti Vibration Pad

Rubber Washers

Chevron Packing Set

PTFE Diaphragm



Rubber Ball

Rubber Spider

Butterfly Valve Sleeve

Rubber Flange gaskets

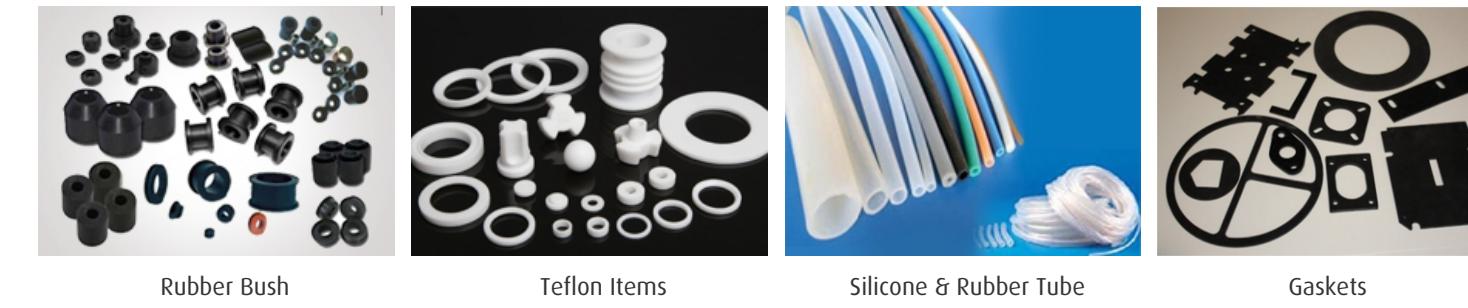

Rubber Bush

Teflon Items

Silicone & Rubber Tube

Gaskets

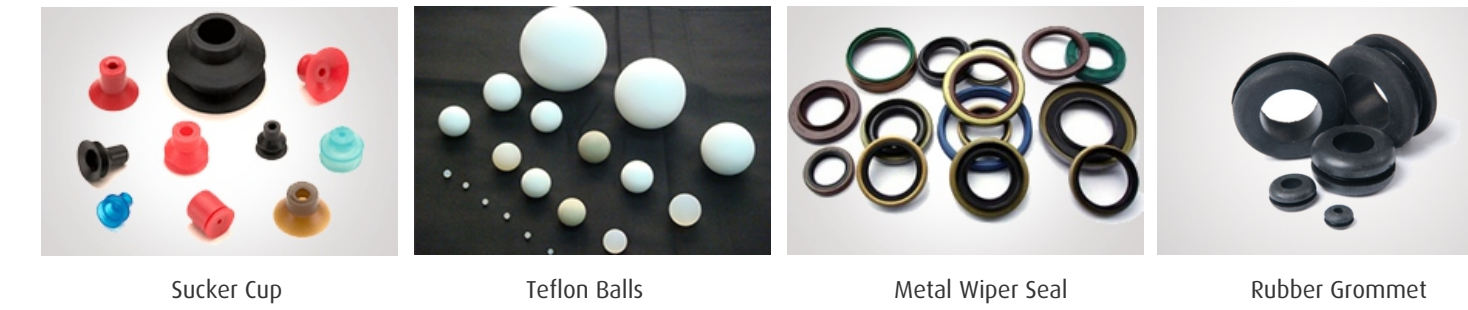

Sucker Cup

Teflon Balls

Metal Wiper Seal

Rubber Grommet



Oring Box

Diaphragms 'O' ring, Oil Seal, Chevron Pkg., Bellows, Roller, Gasket, Bush, Coupling, 'V' Ring, Pad, Belts, Grommets, Sheet, Cords, PTFE Diaphragms, Washers, Ball, Sucker Cup

Metal to Rubber Bonded Parts, Sleeves, Teflon & Nylon Parts etc. As per Sample or Specification.

Quality Materials of Viton, Silicone, P.U. Nitrite,



THE ORIGIN OF SEALING SOLUTIONS.

# HYDRAULICS & PNEUMATIC SEALS

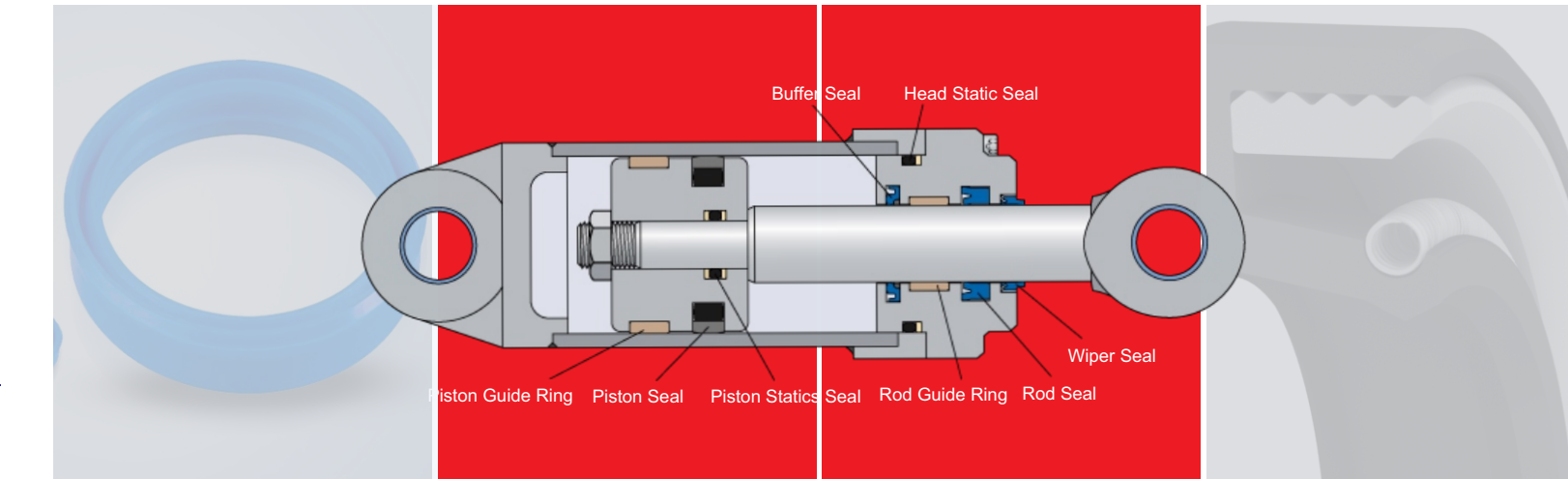

## Rubber Solutions

- Anti Vibration Pad
- Rubber Washers
- Chevron Packing Set
- Rubber Ball
- Rubber Spider
- Butterfly Valve Sleeve
- Rubber Bush
- Teflon Items
- Silicone & Rubber Tube
- Sucker Cup
- Teflon Balls
- Metal Wiper Seal



Our Shop

**Proma Seals Pvt. Ltd.**  
Plot No. PAP J-148, Telco Road, midc, Bhosri, Pune-411026, Maharashtra.



Our Office

**Proma Seals Pvt. Ltd.**  
Plot no 01, ward no. 06, mahajanwadi (wanadongari), Hingna Road, Nagpur -441110,



Contact

+91 70 201 04713 +91 82 371 63678 +91 95 791 07942

+91 97 669 15393 +91 99 678 72858

info@promaseals.com

www.promaseals.com